

Installation Instructions

Compact Path Light

MB560

Thank you for purchasing the Mr Beams® Compact Path Light. We are committed to eliminating darkness using the latest in Light-Emitting Diodes (LEDs). LEDs are the most efficient and durable light sources available. We are certain that your light will contribute to a safer environment and provide light where you need it at a very reasonable cost.

What is included per light:

- 2 Screws
- 1 Stake

What you need to install:

- 1 Small Screwdriver
- 4 AA-Cell Alkaline Batteries (per light)

Path Light Features:

Motion/Light Sensor: Light instantly turns on when it detects motion from up to 12 feet away. The light sensor conserves battery life by preventing the light from activating in daylight.

Auto Shut-off: Light shuts off automatically after 20 seconds if no motion is detected.

Bright LED: 30 lumens cover up to 50 sq ft.

Durable, Weather Resistant: Tight seals and UV resistant material allow the light to work in all weather conditions.

Tips:

- Use only new alkaline AA-Cell batteries with 1.5V rating.
- Do not mix old and new batteries. If batteries are not new, it may cause the light to malfunction.
- Install batteries with polarity in correct position.
- Light may activate when batteries are inserted. Simply take light into a dark room. Allow batteries to settle, then test activation.
- **If your light will not turn off, it means that it is time to replace the batteries.**

A. Mounting with Stake

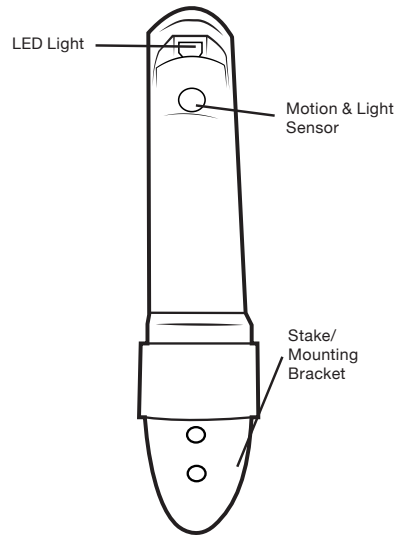

B. Mounting on Wall

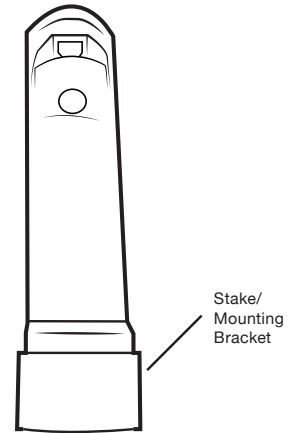

NOTE: Light sensor only allows light to activate in darkness. We recommend you test in a dark room or closet.

Battery Installation

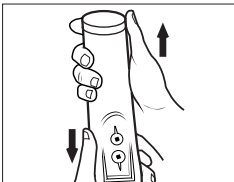

1. Light comes with stake attached. Remove by sliding light out of stake.

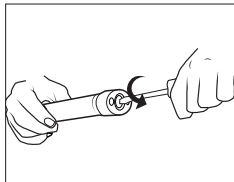

2. Twist screwdriver counter clockwise to remove screw from bottom of light.

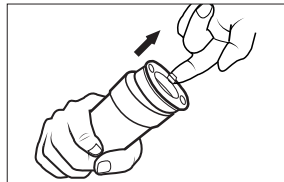

3. Remove battery compartment lid by taking your index finger and lifting the tab.

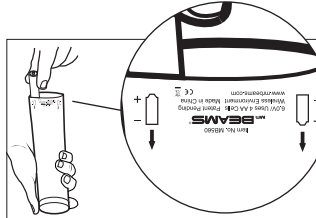

4. Insert 4 AA-Cell batteries according to the position indicated on the light.

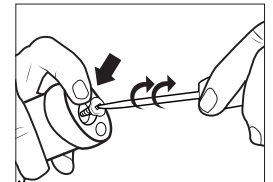

5. Depress the battery lid and twist screw back onto light with screwdriver.

Mounting with Stake

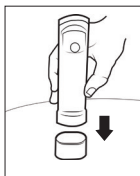
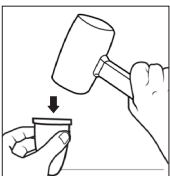

A. Determine location for mounting light. Place piece of wood on top of stake and gently hammer into ground with a hammer or soft mallet. Slide path light into stake until it is seated securely.

Mounting on Wall

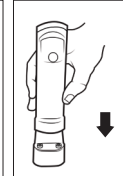
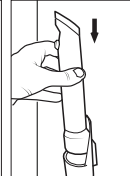
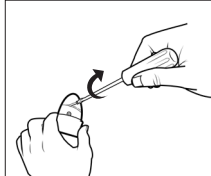

B. Determine mounting location. Drive two screws (included) through holes of mounting bracket. Once mounted on wall, slide path light down into stake until it is securely seated.

Battery Caution:

- 1) Do not mix old and new batteries
- 2) Do not mix Alkaline, Standard (Carbon-Zinc) or Rechargeable (Nickel Cadmium) or (Nickel Metal Hydride) batteries
- 3) Do not dispose of batteries in fire
- 4) Batteries should be recycled or disposed of as per state and local guidelines